

Product Catalog

Divator diving equipment

2025-01



INTERSPIRO

Keeps You Breathing



Keeps you breathing.

Interspiro develops premium respiratory protection and equipment for diving, firefighting, emergency escape and rescue operations. We supply military, police, industries, shipping companies and rescue services all over the globe with standout products for extreme situations

At Interspiro, we've worked for almost a hundred years to keep professionals breathing in hazardous environments. Many of our technological breakthroughs in breathing equipment have become industry standard, such as 300 bar and positive pressure. Today our equipment is used by firefighters and divers all over the world, and we work in close partnership with fire and rescue services, defence, shipping and heavy industry to meet and exceed their requirements.

Visit www.interspiro.com for a look at our latest innovations for your safety. We're already working on new ones.



Content

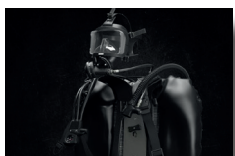

Divator Pro System _____	4
Features _____	5
Configurator - Cylinder pack version _____	6
Configurator - Single cylinder version _____	8
Configurator - DP1 Surface supply system version _____	10

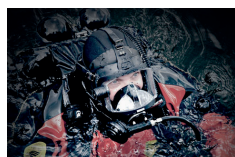

Divator Full face mask _____	12
HUD and Accessory rail system _____	14
Breathing valves and face mask accessories _____	16



Regulators _____	17
Divator Pro regulator units _____	18
Divator RS4 regulator units _____	18



Cylinders _____	19
Composite cylinders _____	20
Steel cylinders _____	21



Surface supply system _____	22
DP1 Surface supply system _____	23
Accessories _____	24

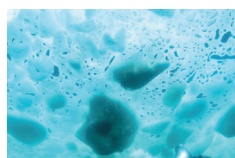

Optional equipment _____	25
Weights and BC accessories _____	26
Accessories _____	27

© 2025 Interspiro AB, Sverige.

This publication contains or refers to proprietary information which is protected by copyright. All rights are reserved. This publication may not be copied, photocopied, reproduced, translated, or converted to any electronic or machine-readable form in whole or in part without prior written approval from Interspiro. Changes or updates to this publication may be made without prior notice.

Divator Pro System

Setting the new standard for professional diving. Again.

The all new Divator Pro System is the first complete diving system for professionals. Combining our legendary Divator mask (to some known as the Aga mask) with your choice of regulator and cylinder and the brand new harness / BC, Interspiro Divator Pro offers versatility performance and durability like no other.

With a wide range of available choices you can customize your Divator Pro system to fit your specific needs.





Pressure gauge

Robust shockproof design with rubber cover and easily read pressure gauge with warning device.

Weight belt

The position of the weight can be adjusted on the belt for better balance.

Hoses

Hose routing adapted to minimize the risk of getting stuck.

Harness

The harness is easy to clean and quick-drying. The body-shaped non-textile shoulder straps and hip belt prevents contamination.

Adjustment

Easy adjustment for different body size.

Quick coupling

Quick coupling for cylinder pack or single cylinder.



Divator Pro Configur

Harness		
Art. No.		Name
PRO-H-	A	Pro Harness
PRO-H-	B	Pro Harness w weights 2 x 4,5 kg
PRO-H-	C	Pro Harness w weights 2 x 3,5 kg

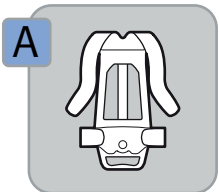

Pro Harness

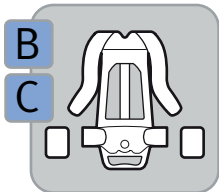

Pro Harness with weights

Bladder		
Art. No.		Name
PRO-B-	A	Pro Bladder
PRO-B-	B	Pro Bladder and inflation cyl.
PRO-B-	E	Pro Rescue Bladder
	o	None

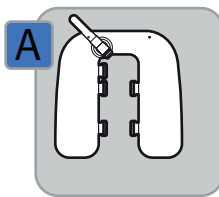

Pro Bladder

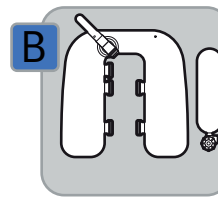

Pro Bladder and inflator cylinder

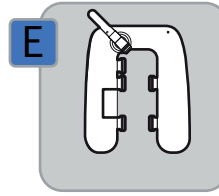

Pro Rescue Bladder

Cylinders		
Art. No.		Name
PRO-D-CYL-	A	Pro Cylinder pack
PRO-D-CYL-	B	Pro Cylinder pack
PRO-D-CYL-	C	Pro Cylinder pack
PRO-D-CYL-	D	Pro Cylinder pack
	o	None

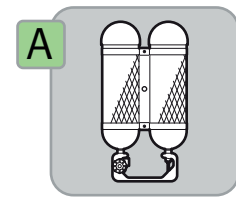

Pro Cylinder pack Composite 2x7,2 l

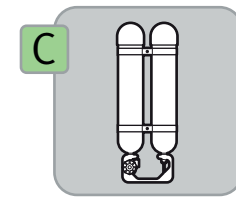

Pro Cylinder pack Steel 2x6 l

Full-face mask		
Art. No.		Name
FFM-	A	FFM NR Black
FFM-	B	FFM NR Black w hatch
FFM-	C	FFM NR Grey
FFM-	D	FFM NR Grey w hatch
FFM-	E	FFM Silicone Black
FFM-	F	FFM Silicone Black w hatch
FFM-	G	FFM Silicone Yellow
FFM-	H	FFM Silicone Yellow w hatch
	o	None

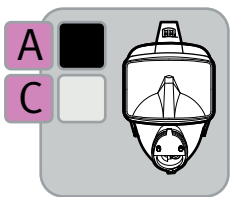

FFM NR

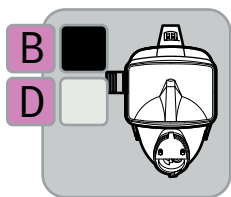

FFM NR with hatch

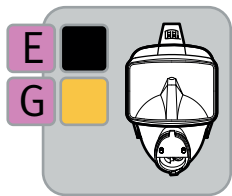

FFM Silicone

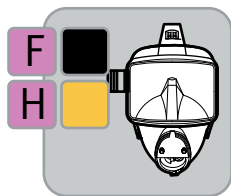

FFM Silicone w hatch

O* *can only be chosen when choosing breathing valve with mouthpiece:



Octopus		
Art. No.		Name
OCT-	A	Octopus with 170 cm hose
OCT-	B	Octopus with 135 cm hose
	o	None

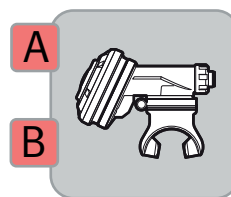

Octopus with hose

Divator Pro Configur
Cylinder pack versio

ator Cylinder pack

	Regulator			Breathing valve		
	Art. No.		Name	Art. No.		Name
k 2x7,2 liter incl. weight	PRO-D-REG-	A	Pro Regulator w warning, bar	BV-	A	Breathing valve w mouthpiece
k 2x3,5 liter incl. weight	PRO-D-REG-	B	Pro Regulator w warning + DP1, bar	BV-	B	Breathing valve for FFM w/o SP
k 2x6 liter	PRO-D-REG-	C	Pro Regulator w warning, psi	BV-	C	Breathing valve for FFM w SP
k 2x4 liter	PRO-D-REG-	D	Pro Regulator w warning + DP1, psi		o	None
		o	None			

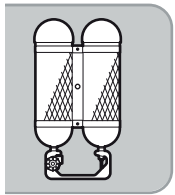

Pro Cylinder pack composite 2x3,5 l

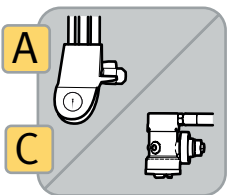

Pro regulator w warning BAR & PSI

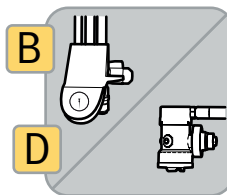

Pro regulator w warning DP1, BAR, PSI

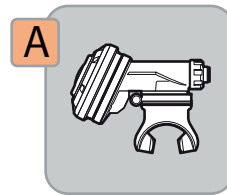

Breathing valve w mouthpiece

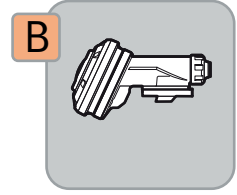

Breathing valve for FFM w/o SP

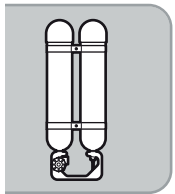

Pro Cylinder pack Steel 2x4 l

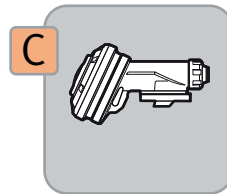

Breathing valve for FFM w SP

Dry Suit hose		
Art. No.		Name
H-	A	CEJN connection
	o	None

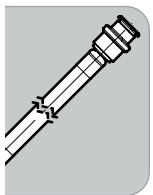

Dry Suit hose with CEJN connection

High-pressure accessory			
Art. No.			Name
HP-D-	A		Divator HUD 55 bar
HP-D-	B		Divator HUD 80 bar
	o		None

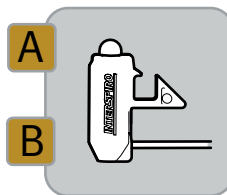

Divator HUD 55 & 80 bar

Example:

PRO-D- B A A A B A o A A

- Pro Harness with weights 2 x 4.5 kg
- Pro Bladder
- Pro Cylinder pack 2 x 7,2
- Pro Regulator with warning, bar
- Breathing valve for FFM w/o SP
- FFM NR Black
- No Octopus (zero)
- CEJN Dry Suit Hose
- Divator HUD 55 bar

Generates Divator Pro System article number: PRO-D-BAAABoAA

ator
on

Divator Pro Configur

Harness		
Art. No.		Name
PRO-H-	A	Pro Harness
PRO-H-	B	Pro Harness w weights

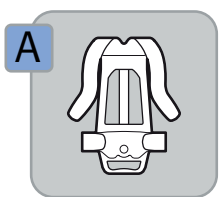

Pro Harness

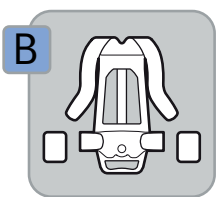

Pro Harness with weights

Bladder		
Art. No.		Name
PRO-B-	A	Pro Bladder
PRO-B-	B	Pro Bladder and inflation cyl.
PRO-B-	E	Pro Rescue Bladder
	o	None

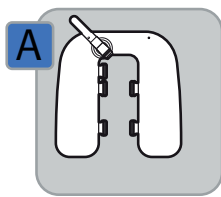

Pro Bladder

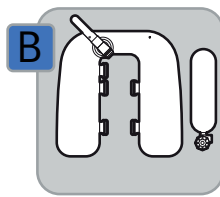

Pro Bladder and inflation cylinder

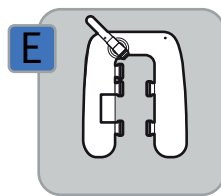

Pro Rescue Bladder

Cylinder		
Art. No.		Name
PRO-S-CYL-	A	Pro Single C
PRO-S-CYL-	B	Pro Single C
PRO-S-CYL-	C	Pro Single C
PRO-S-CYL-	Z	Pro Single C
	o	None

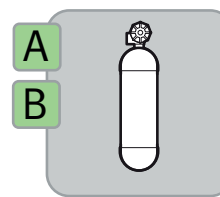

Pro Single Cyl. steel 4 & 6 liter



Pro Si

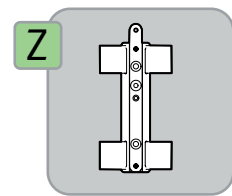

Pro Single Cyl. Mounting kit

Full-face mask		
Art. No.		Name
FFM-	A	FFM NR Black
FFM-	B	FFM NR Black w hatch
FFM-	C	FFM NR Grey
FFM-	D	FFM NR Grey w hatch
FFM-	E	FFM Silicone Black
FFM-	F	FFM Silicone Black w hatch
FFM-	G	FFM Silicone Yellow
FFM-	H	FFM Silicone Yellow w hatch
	o	None

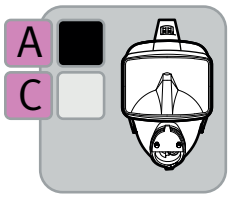

FFM NR

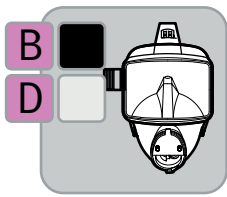

FFM NR with hatch

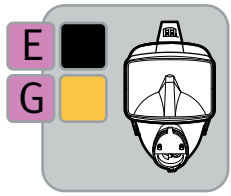

FFM Silicone

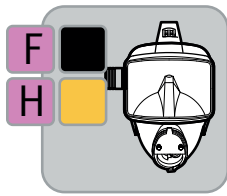

FFM Silicone w hatch

O* *can only be chosen when choosing breathing valve with mouthpiece:



Octopus		
Art. No.		Name
OCT-	A	Octopus (w hose and oct. holder)
	o	None

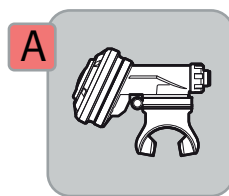

Octopus w hose and holder

Divator Pro Configur
Single cylinder vers

ator Single cylinder

	Regulator			Breathing valve	
	Art. No.		Name	Art. No.	Name
Cyl. steel 4 liter	PRO-S-REG-	A	Pro Regulator w warning, bar	BV-	A Breathing valve w mouthpiece
Cyl. steel 6 liter	PRO-S-REG-	B	Pro Regulator w warning + DP1, bar	BV-	B Breathing valve for FFM w/o SP
Cyl. steel 10 liter	PRO-S-REG-	C	Pro Regulator w warning, psi	BV-	C Breathing valve for FFM w SP
Cyl. mounting kit	PRO-S-REG-	D	Pro Regulator w warning + DP1, psi		o None
	PRO-S-REG-	J	Pro Regulator, bar		
	PRO-S-REG-	K	Pro Regulator + DP1, bar		
	PRO-S-REG-	L	Pro Regulator, psi		
	PRO-S-REG-	M	Pro Regulator + DP1, psi		
		o	None		

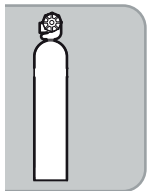

Single Cyl. steel 10 liter

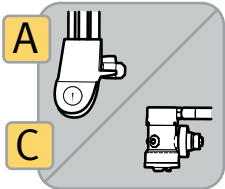

Pro regulator w warning BAR

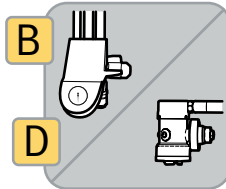

Pro regulator w warning DP1, BAR

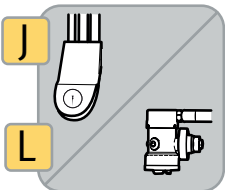

Pro regulator w warning PSI

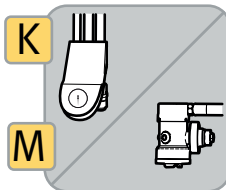

Pro regulator w warning DP1, PSI

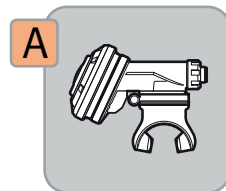

Breathing valve w mouthpiece

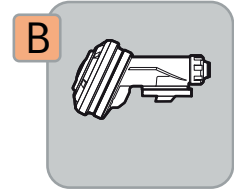

Breathing valve for FFM w/o SP

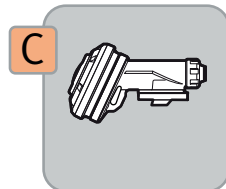

Breathing valve for FFM w SP

Dry Suit hose	
Art. No.	Name
SH-	A CEJN connection
	o None

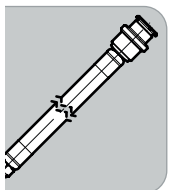

Suit hose with CEJN connection

High-pressure accessory	
Art. No.	Name
HP-S-	A Divator HUD 55 bar
HP-S-	B Divator HUD 80 bar
	o None

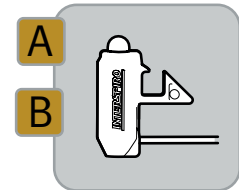

Divator HUD 55 & 80 bar

Example:

PRO-S- B A A A B A o A A

- Pro Harness with weights
- Pro Bladder
- Pro Cylinder 4 liter steel
- Pro Regulator with warning, bar
- Breathing valve for FFM w/o SP
- FFM NR Black
- No Octopus (zero)
- CEJN Dry Suit Hose
- Divator HUD 55 bar

Generates Divator Pro System article number: PRO-S-BAAABAoAA

Divator Pro Configurati

Surface unit, 75 bar		
Art. No.		Name
DP1-PRO-S-	A	Surface panel, bar
DP1-PRO-S-	B	Surface panel, psi
	o	None

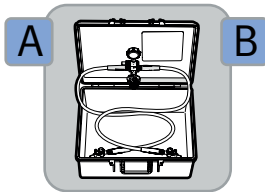

Surface panel
w bar or psi

DP1 Hose				Type	Name
Art. No.		Name			
DP1-PRO-H-	A	DP1 Pro Hose 10 meters	A	Commun	
DP1-PRO-H-	B	DP1 Pro Hose 20 meters	B	Commun	
DP1-PRO-H-	C	DP1 Pro Hose 30 meters	C	Commun	
DP1-PRO-H-	D	DP1 Pro Hose 40 meters	D	Commun	
DP1-PRO-H-	E	DP1 Pro Hose 50 meters	o	None	
DP1-PRO-H-	F	DP1 Pro Hose 60 meters			
DP1-PRO-H-	G	DP1 Pro Hose 70 meters			
DP1-PRO-H-	H	DP1 Pro Hose 80 meters			
DP1-PRO-H-	I	DP1 Pro Hose 90 meters			
DP1-PRO-H-	J	DP1 Pro Hose 100 meters			
DP1-PRO-H-	K	DP1 Pro Hose 110 meters			
DP1-PRO-H-	L	DP1 Pro Hose 120 meters			



Comm
w/
cc

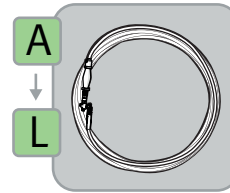

DP1 Pro hose
10 - 120 meter

Winding frame / bag		
Art. No.		Name
DP1-BAG-	A	Winding frame
DP1-BAG-	B	Winding frame in Pelicase
DP1-BAG-	C	Pelicase
DP1-BAG-	D	Soft bag
	o	No frame, bag or Pelicase

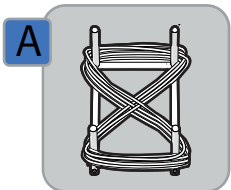

Winding frame

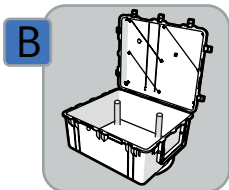

Winding frame in
pelicase

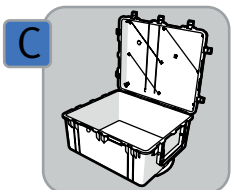

Pelicase

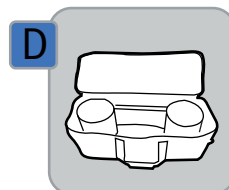

Soft bag

Option		
Art. No.	Name	
OCT-ACC-	A	Octopus connected to P+ reg.
	o	No accessories

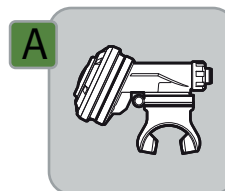

Octopus

Divator Pro Confi
DP1 version



or Surface Supply DP1

Communication cable	Depth marking / sleeve	
	Type	Name
Communication cable without any connectors	A	Depth marking
Communication cable with Ibsophone connectors	B	Yellow sleeve
Communication cable with OTS Hi -use	C	Yellow sleeve and depth marking
Communication cable with OTS Hi -use / AMP 4	o	None

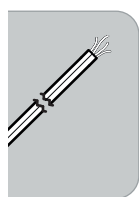

Communication cable with different connectors

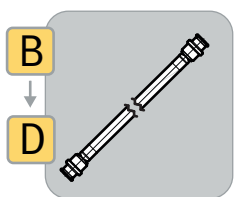

Communication cable with different connectors

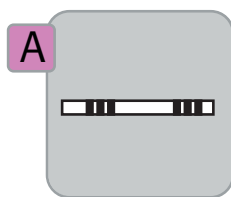

Depth marking

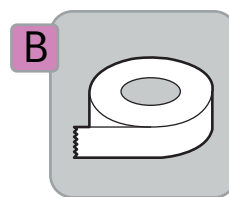

Yellow sleeve

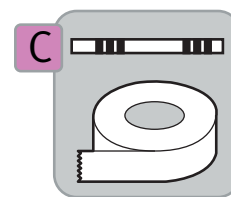

Depth marking & yellow sleeve

Note! This DP1 system can only be used with the Divator Pro system.

Example:

DP1-PRO- A F B A B o

- Surface panel bar
- DP1 Hose 60 meter
- Communication cable with Ibsophone connectors
- Depth marking
- Winding frame in Pelicase
- No option

Generates DP1 adapted for Divator Pro with article number: DP1-PRO-AFBABo

gurator





Divator Full face mask

Every day this mask stands up to the toughest diving conditions. Through decades of innovation and refinement, it has mastered the secrets of the sea. Users have saved both man and beast, seen dictatorships fall and freedom rise, even greeted astronauts returning from the Moon by way of ocean landing. It might be old news for professionals around the world, but performing well where others fail never gets old.



Divator Full face mask



- 1.** CE approved for cold water diving. **2.** Part of a complete diving system, with full CE approval. **3.** Positive pressure available for increased safety. **4.** Excellent ergonomic and comfort. **5.** Low life cycle cost. **6.** Breathing valve can also be used with mouthpiece. **7.** Inner mask can be replaced. **8.** Natural rubber is durable and resistant to oil and chemicals etc. **9.** Easy and safe to use. Push-pull hatch as option. **10.** E-learning level 1 included. **11.** Available in S and XL, if needed.

Breathing valve

The DIVATOR breathing valve is one of the best-tested breathing valves available. It will perform even in the most extreme of conditions: mud, oil, and fast flowing cold currents does not have a serious impact on the performance. The breathing valve is balanced and maintain extremely low breathing resistance at all diving depths even if variations occur in the secondary pressure. The combination of high air flow capacity and low breathing resistance increases the divers performance and endurance.

Full face mask



Full face mask with breathing valve

Part No.	Description
96319-01	Yellow silicone mask without safety pressure
96319-02	Yellow silicone mask with safety pressure
96319-03	Gray natural rubber mask without safety pressure
96319-04	Gray natural rubber mask with safety pressure
96319-05	Black silicone mask without safety pressure
96319-06	Black silicone mask with safety pressure
96319-10	Black natural rubber mask without safety pressure
96319-11	Black natural rubber mask with safety pressure



Full face mask with hatch and breathing valve

Part No.	Description
96319-14	Yellow silicone mask without safety pressure
96319-15	Yellow silicone mask with safety pressure
96319-12	Gray natural rubber mask without safety pressure
96319-13	Gray natural rubber mask with safety pressure
96319-16	Black silicone mask without safety pressure
96319-17	Black silicone mask with safety pressure
96319-20	Black natural rubber mask without safety pressure
96319-21	Black natural rubber mask with safety pressure



Full face mask without breathing valve

Part No.	Description
FFM-G	Yellow silicone mask
FFM-C	Gray natural rubber mask
FFM-E	Black silicone mask
FFM-A	Black natural rubber mask



Full face mask with hatch and without breathing valve

Part No.	Description
FFM-H	Yellow silicone mask
FFM-D	Gray natural rubber mask
FFM-F	Black silicone mask
FFM-B	Black natural rubber mask



Mask visor with hatch

Part No.	Description
96962-01	Visor with mounted hatch. For upgrade of mask.

Hatch

The DIVATOR hatch consists of an ambient breathing valve mounted on the side of the full face mask visor - not interfering with the field of vision - and gives the diver ambient air while on stand-by or at surface level.

The hatch is easy to operate: pull to open and push to close.

Ambient breathing will not only increase cylinder duration time but will enable the diver to keep the full face mask donned while on stand-by.

HUD and Accessory rail system

There are two HUD (Heads-Up Display) versions; one with a warning level of 55 bar/800 psi and one with a warning level of 80 bar/1160 psi. The HUD is equipped with an universal 7/16 inch HP connection which will fit most standard diving regulators.

HUD with 55 bar/800 psi Warning level

Part No.	Description
89100-01	With 1.75 meter (68") cable
89100-02	With 2.95 meter (116") cable
89100-03	With 1.45 meter (57") cable
89100-04	With 1.2 meter (47") cable
89100-05	With 2.45 meter (96") cable
HP-D-A	Pro-HUD

HUD with 80 bar/1160 psi Warning level

Part No.	Description
89100-11	With 1.75 meter (68") cable
89100-12	With 2.95 meter (116") cable
89100-13	With 1.45 meter (57") cable
89100-14	With 1.2 meter (47") cable
89100-15	With 2.45 meter (96") cable
HP-D-B	Pro-HUD

HUD Connectors

Part No.	Description
97193-51	HP connection G 1/8" M x 1/8" F + 7/16"
89140-01	HP Connection 3 x 7/16 adjustable + male/female G 1/8
89140-02	HP Connection 7/16 adjustable + male/female M8x1



With the Accessory rail system you can easily attach accessories like the Interspiro welding visor, divelight, video head or any type of lamp to your DIVATOR full face mask.

Accessory rail system

Part No.	Description
30582-51	Rail holder (for left or right mounting on FFM)
30584-51	Universal mount (incl. two sizes of hoseclamps)
32315-51	Slide mount (for divelight)
31520-51	Go Pro camera mount
32316-52	Divelight (needs 2 x AA/LR batteries, not included)
30581-51	Welding visor * (Welding glass DIN 7 included)
31078-51	Batteries AA, 10 pack

* Two rail holders (Part No. 30582-51) needed for mounting.

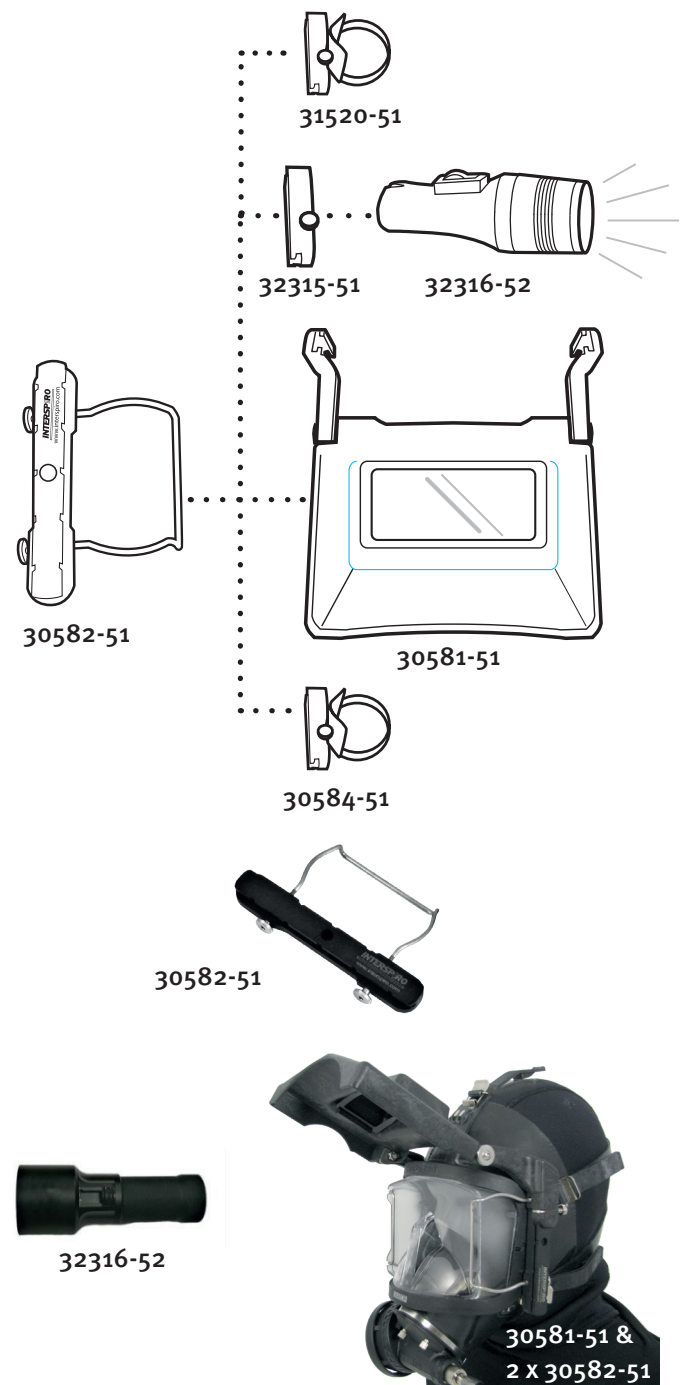

Breathing valves and face mask accessories



Breathing valve for full face mask

Part No.	Description
BV-C	Black with safety pressure
BV-B	Black



Octopus breathing valve

Part No.	Description
OCT-A	Complete with holder and 1,7m hose.
97199-02	Octopus with yellow shield ring and locking lever.



Breathing valve with mouthpiece

For autonomous diving

Part No.	Description
BV-A	Black breathing valve with mouthpiece.



Mouthpiece kit

Part No.	Description
336190353	Complete mouthpiece kit



Mouthpiece clamp

Part No.	Description
51098-51	Mouthpiece clamp



Mask visor weights

Part No.	Description
336190854	Mask visor weights, complete, pair (2 x 350 gram)



Mask cover

Part No.	Description
460190555	Black front cover lid for the full face mask



Spectacle kit

Part No.	Description
96496-51	For mounting of prescription lenses inside the full fae mask (lenses not included)



Pressure equalizing pad

Part No.	Description
88542-51	Pressure equalizing pad, four slots, EPDM rubber
460190513	Pressure equalizing pad, OTS microphone



Head harness

The head harness is made in one piece of natural rubber.

Part No.	Description
460190457	Head harness, black natural rubber



Mask bag

Part No.	Description
96484-51	Mask storage bag
96484-52	Mask storage bag with ID holder
331950280	Mask bag with handle

Mask visor weights

The DIVATOR mask visor weights can be attached to the full face mask in order to compensate the mask's buoyancy.

When diving for prolonged periods of time, using visor weights is recommended practice.

Can not be used together with a hatch.

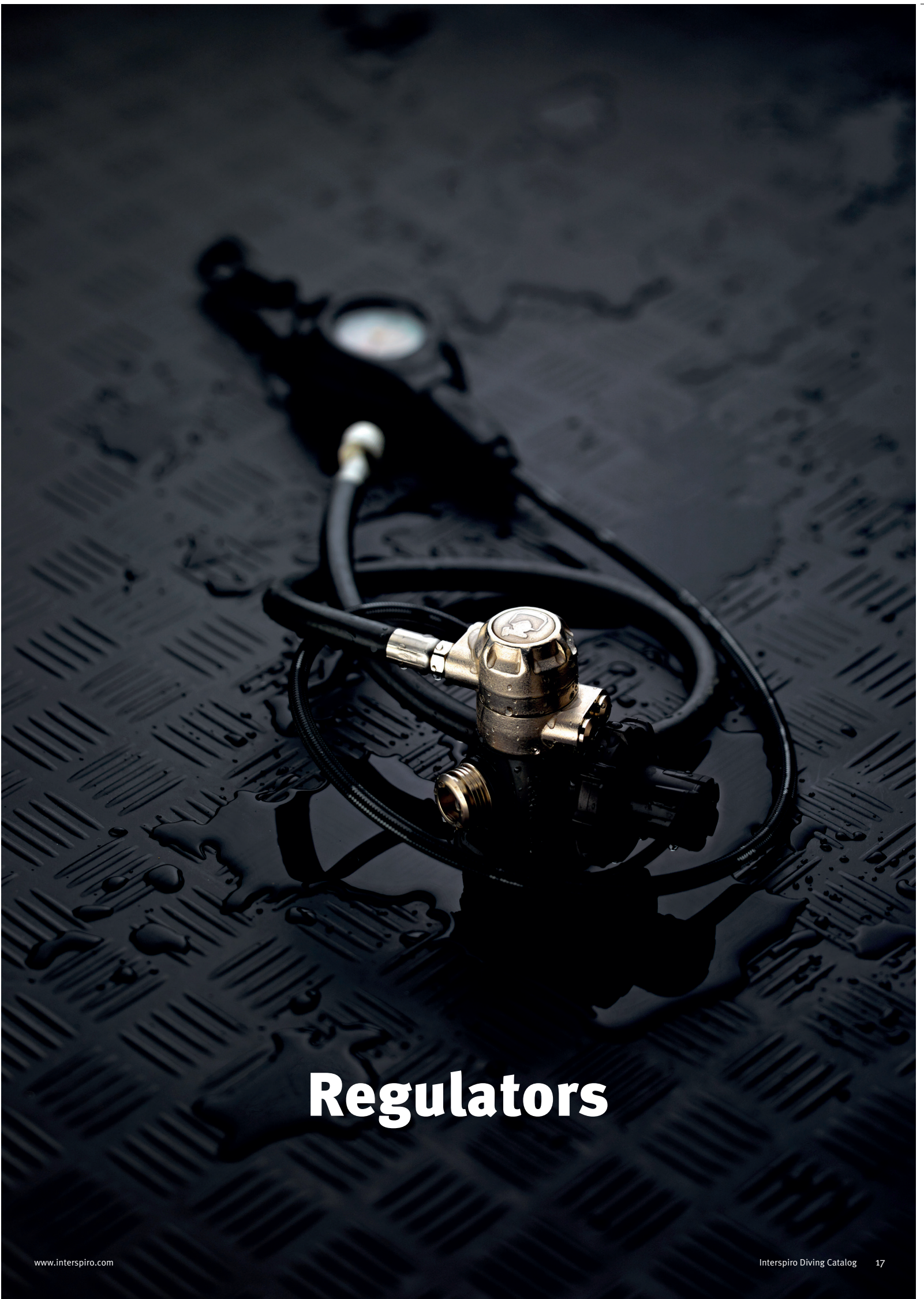

Regulators



Divator Pro regulator units

The available configurations and part numbers are defined in the Divator Pro product configurators, see section Divator Pro System in this catalog.

Divator RS4 regulators units



RS4 Regulator - 2-port SCUBA (dry suit/BC)

One outlet equipped with over pressure valve. The two HP outlets fitted with blank plugs. Delivered without pressure gauge.

Part No.	Description
32940-01	DIN cylinder connection
32940-02	Yoke cylinder connection



RS4 Regulator - 2-port SCUBA + DP1

Delivered with DP1 surface supply connection and basic pressure gauge (some models).

Part No.	Description
32960-01	Bar pressure gauge, DIN cylinder connection
32960-02	Bar pressure gauge, Yoke cylinder connection
32960-11	Psi pressure gauge, DIN cylinder connection
32960-12	Psi pressure gauge, Yoke cylinder connection
32960-21	DIN cylinder connection, No pressure gauge
32960-22	Yoke cylinder connection, No pressure gauge

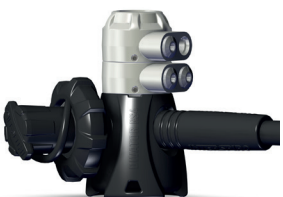

RS4 Regulator - 4-port SCUBA

Delivered with basic pressure gauge (some models).

Part No.	Description
32950-01	Bar pressure gauge, DIN cylinder connection
32950-02	Bar pressure gauge, Yoke cylinder connection
32950-11	Psi pressure gauge, DIN cylinder connection
32950-12	Psi pressure gauge, Yoke cylinder connection
32950-21	DIN cylinder connection, No pressure gauge
32950-22	Yoke cylinder connection, No pressure gauge

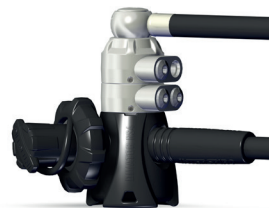

RS4 Regulator - 4-port SCUBA + DP1

Delivered with DP1 surface supply connection and basic pressure gauge (some models).

Part No.	Description
32970-01	Bar pressure gauge, DIN cylinder connection
32970-02	Bar pressure gauge, Yoke cylinder connection
32970-11	Psi pressure gauge, DIN cylinder connection
32970-12	Psi pressure gauge, Yoke cylinder connection
32970-21	DIN cylinder connection, No pressure gauge
32970-22	Yoke cylinder connection, No pressure gauge

Basic Pressure gauge

Part No.	Description
32948-01	Bar gauge
32948-02	Psi gauge

Depth gauge

Part No.	Description
32941-51	Scale in meters
32941-52	Scale in feet

Compass

Part No.	Description
32942-01	For northern hemisphere
32942-02	For southern hemisphere

92941-51 / 32941-52

32948-01 / 32948-02



32942-01 / 32942-02



Cylinders

Interspiro's DIVATOR LITE, is the first complete professional diving system designed specifically for the search and rescue diver. The DIVATOR LITE Cylinder System combines an ultra lightweight non-metal composite cylinder with a balanced and adjustable weight system. This cylinder system dramatically increases the diver's safety and comfort.

The DIVATOR steel cylinders all have a very low profile and no protruding parts, which reduces the risk of getting caught in obstacles and ensures less water resistance. The cylinder design is robust and suitable for diving in demanding environments.



Composite cylinders



1. Lightest diving cylinders in the world out of water. 2. Perfectly balanced under water. 3. Low profile allows for safer access to confined spaces and minimizes resistance in current waters. 4. Quick cylinder attachment interfact to harness or BC. 5. Removable compensating weight between the cylinders. 6. The regulator position simplifies cylinder valve handling and the carrying handle protects the regulator. 7. The first composite cylinder approved by US Department of Transportation (DOT) for underwater use in the United States.

Divator Pro Cylinder pack cylinders

Part No.	Description
PRO-D-CYL-A	Pro cylinder pack 2x7.2 liter
PRO-D-CYL-B	Pro cylinder pack 2x3.5 liter

Divator Lite cylinders - PED, CE and DOT Approved

Part No.	Description
98853-11	Cylinder pack 323.4 2x3,5 liter
98857-11	Cylinder pack 326.7 2x7,2 liter

Pre-delivery cylinder filling

Part No.	Description
32300-01	Pre-delivery cylinder filling

NOTE! Cylinder are by default delivered without air (only with safety pressure). For delivery of filled cylinders add this item (same quantity as the quantity of cylinders).

Divator Lite cylinders upgrade kit

Part No.	Description
57614-51	Upgrade kit for Pro 323,4
57614-52	Upgrade kit for Pro 326,7
57614-53	Upgrade kit for Pro 324
57614-54	Upgrade kit for Pro 326



Cylinder pack handle

Part No.	Description
31710-51	Cylinder pack handle
31710-52	Cylinder pack handle, 10 pack



Divator lite cylinder weights

Part No.	Description
97520-11	13.8 kg weight for 326.7 & 2x7.2 L cylinder pack
97520-12	11.4 kg weight for 325 & 326.7 & 2 x 7.2 L cylinder pack
97520-13	9.3 kg weight for 323.4 & 2 x 3.5 L cylinder pack



Cylinder weights accessories

Part No.	Description
97869-51	Weight substitute for 325 & 326.7 & 2 x 7.2 L cylinder pack
97869-52	Weight substitute for 323.4 & 2 x 3.5 L cylinder pack
88199-51	Handle protection kit for 5 cylinder weights. For mounting on older cylinder weights without handle protection, or as spare part.

Steel cylinders

The DIVATOR steel cylinders all have a very low profile and no protruding parts, which reduces the risk of getting caught in obstacles and ensures less water resistance. The cylinder design is robust and suitable for diving in demanding environments.

DIVATOR steel cylinder packs and single cylinders all have an easily accessible cylinder valve and are equipped with a quick connect interface to DIVATOR harness or BCW's.



Steel cylinder pack

Part No.	Description
98412-02	Cylinder pack 324 PED, 2 x 4 liter, (2400 L/ 85 ft ³)
98412-04	Cylinder pack 324, 2 x 4 liter Matte Black, (2400 L/ 85 ft ³)
98411-02	Cylinder pack 326 PED, 2 x 6 liter, (3600 L/ 127 ft ³)
98411-04	Cylinder pack 326, 2 x 6 liter, Matte Black, (3600 L/ 127 ft ³)
98411-03	Cylinder pack 326 with Easy-fill connection, for filling cylinder with a mounted regulator, 2 x 6 liter
98411-05	Cylinder pack 326, Matte Black with Easy-fill connection, for filling cylinder with a mounted regulator, 2 x 6 liter

Divator Pro cylinder pack

Part No.	Description
PRO-D-CYL-C	Pro Cylinder pack 2 x 6 L
PRO-D-CYL-D	Pro Cylinder pack 2 x 4 L

Steel single cylinder

Part No.	Description
98445-01	Single cylinder 316 (1800 L/ 63 ft ³)

Divator Pro single cylinders

Part No.	Description
PRO-S-CYL-A	Pro single cylinder 4 L
PRO-S-CYL-B	Pro single cylinder 6 L
PRO-S-CYL-C	Pro single cylinder 10 L



Pre-delivery cylinder filling

Part No.	Description
32300-01	Pre-delivery cylinder filling

NOTE! Cylinder are by default delivered without air (only with safety pressure). For delivery of filled cylinders add this item (same quantity as the quantity of cylinders).



Cylinder pack handle

Part No.	Description
31710-51	Cylinder pack handle
31710-52	Cylinder pack handle, 10 pack

Easy-fill connection

The easy-fill connection is designed for filling cylinder packs (composite or steel) that have a mounted regulator.





Surface Supply System

The DIVATOR DP1 surface supply hose provides a truly light weight and portable surface supply. The DP1 provide full cylinder pressure to the diver at depth.

The supply hose is also approved in accordance with requirements for lifelines and can therefore act as a safety lifeline.



Divator DP1 Surface Supply System



- 1. No need for manual adjustment of pressure for various depths which relieves the attendant's work load.
- 2. The surface supply is simplified so that the attendant can focus on the safety of the diver.
- 3. The light and compact design allows rapid deployment when operating in remote or difficult terrain.
- 4. The small diameter of the lightweight supply hose greatly reduces resistance in current waters.

NOTE! This DP1 system cannot be used with Divator Pro. See page 10-11 for Pro compatible system



DP1 Surface Panel

Part No.	Description
DP1-PRO-S-A	75 bar version
DP1-PRO-S-B	1088 psi version



DP1 Supply hose for MKII, MKII and Rs4

Part No.	Description
96725-01	60 meter hose (200 ft)
96725-02	70 meter hose (230 ft)
96725-03	30 meter hose (98 ft)
96725-04	120 meter hose (394 ft)
96725-05	10 meter hose (33 ft)
96725-06	90 meter hose (295 ft)
96725-07	80 meter hose (266 ft)
96725-08	230 feet hose (70 m) with communication cable (without connectors) and sleeve
96725-09	98 feet hose (30 m) with communication cable (without connectors) and sleeve
96725-10	200 feet hose (60 m) with communication cable (without connectors) and sleeve

DP1 Supply hose for Divator Pro

The available configurations and part numbers are defined in the Divator DP1 product configurator in the section Divator Pro System in this catalog.

Accessories

The DIVATOR DP1 surface supply hose provides a truly light weight and portable surface supply. The DP1 provide full cylinder pressure to the diver at depth.

Accessories

Part No.	Description
97373-51	Vent, pressure relief and protective handle. Male IS connection.
88139-51	Holder strap with hook.
97335-51	"OPEN" tag, for marking open cylinder.
336921843	Carabiner hook, Stainless steel 316
96741-51	Safety belt



Holdall & Hose winding frame

Part No.	Description
DP1-BAG-D	Holdall for DP1 hose with winding posts. Fits up to a 60 meter DP1 hose.
DP1-BAG-A	Hose winding frame, lightweight with rubber fastening straps (fits in Pelicase DP1-BAG-C)



Pelicase

Part No.	Description
DP1-BAG-C	Box for DP1 hose



DP1 Upgrade

Part No.	Description
57650-01	for upgrade hose to DP1 Pro version.



Optional equipment

Interspiro offers a wide selection of auxiliary equipment for work in hazardous environments on land and in water. Discover why professional divers in over 50 countries rely on Interspiro when going to work in extreme conditions.



Weights & BC accessories

The DIVATOR weight system is Interspiro's multi-purpose environmentally friendly brass weight that can be used for a wide range of applications.

Weight system



Part No.	Description
88174-51	Weight, 500 g (1 kbs)

Chest weight pocket / Belt weight pocket



Part No.	Description
88135-01	Weight pocket without weights
88175-51	Weight pocket with two weights

Divator Pro weights



Part No.	Description
87071-51	Pro weight 3 kg
87071-52	Pro weight 2 kg
87096-51	Pro weight holder assy

Inflation cylinders (fits all models including Pro)



Part No.	Description
57512-51	Inflation cylinder 0.35 L - left side (as worn on diver). 90° angled, robust hand wheel and a bleed valve.



57512-52	Inflation cylinder 0.35 L - right side (as worn on diver). 90° angled, robust hand wheel and a bleed valve.
----------	-------------------------------------------------------------------------------------------------------------

Divator Pro BC accessories



Part No.	Description
57549-51	Pro holder for inflation cylinder



57548-52	Pro connection inflation cylinder
----------	-----------------------------------



57547-51	Pro BC inflation kit
87150-06-80	Pro inflation hose MP, 80 cm
87150-06-100	Pro inflation hose MP, 100 cm
87150-06-110	Pro inflation hose MP, 110 cm
87150-06-120	Pro inflation hose MP, 120 cm

Accessories

Breathing hoses and connections

Part No.	Description
88119-51	90 degree breathing hose connection with swivel function
336190389	Breathing hose UNF 3/8, 725 mm (28"), US



Dry suit inflation hoses

Part No.	Description
97474-53	Cejn 221 - UNF 3/8 locked, 750 mm (29")
97474-63	Cejn 221 - UNF 3/8 unlocked, 750 mm (29")
97474-54	Cejn 221 - UNF 3/8 locked, 1 meter (39")
97474-64	Cejn 221 - UNF 3/8 unlocked, 1 meter (39")



BC inflation hoses

Part No.	Description
30411-51	BC inflation hose UNF 3/8, 1.15 M / 45 inch
30411-52	BC inflation hose UNF 3/8, 1.28 M / 50 inch
30411-53	BC inflation hose UNF 3/8, 0.51 M / 20 inch
30411-54	BC inflation hose UNF 3/8, 0.75 M / 29 inch



Octopus or breathing hose

Part No.	Description
99007-51	Octopus hose UNF 3/8, 1.7 meter (70")
99007-52	Octopus hose UNF 3/8, 1.13 meter (44")
99007-53	Octopus hose UNF 3/8, 1 meter (39")
99618-51	Octopus hose UNF 3/8, 0.827 meter (32")



Octopus holders

Part No.	Description
88115-51	Octopus holder clip (5 pack)
30643-51	Octopus hose holder kit, for harness or BC (pair)
30780-01	Octopus mouthpiece holder kit (incl. velcro strap)
30776-51	Velcro straps for mouthpiece holder kit, 10 pack



Hoses must only be installed by a holder of a valid Interspiro service certificate on Level 3.

Locked / unlocked suit inflation hose

LOCKED:

The lock ring is locked and cannot be screwed towards the connector. Use when there is a need to disconnect the hose from the dry suit during a dive.

UNLOCKED:

The lock ring is unlocked and can be screwed towards the connector. This will lock the hose to the dry suit. Securing it from being removed during the dive.

Accessories

Swivels, adapters & connections

Connectors mainly suited for MKII regulators.



Part No.	Description
460190716	Adapter G 1/8 male - UNF 3/8 female
30182-51	Adapter G 1/8 female - 3/8 UNF male

Filling accessories



Part No.	Description
331190627	Air filling hose 300 > 200 bar, DIN 5/8
99404-03	Air filling hose 300 > 300 bar, DIN 5/8
69018-51	Filling hose
99369-01	Filling restrictor adapter, 90 degree angle
99369-05	Filling adapter
99804-01	Control gauge, with bar scale, DIN 5/8
99804-02	Control gauge, with psi scale, DIN 5/8
460190770	Discharge plug (DIN). Controlled, will leave 2 bar (29 psi) safety pressure

Protective caps



Part No.	Description
460190557	Plastic protective cap R 5/8 (yellow), 10 pack
31391-51	Dust cover, small, Ø10-12 mm, 10 pack
31392-51	Dust cover, large, Ø22-26 mm, 10 pack
95198-51	Protective plug R 5/8, brass
460190077	Protective plug R 5/8, brass, 5 pack

Plugs

Part No.	Description
460190220	Cylinder valve plug G 5/8
97192-51	Blind plug 7/16"
460190755	Plug hex socket head UNF 3/8, 2 pack
460190418	Plug hex head G 1/8
336200721	Protective plug R 5/8, brass, 5 pack

Compounds



Part No.	Description
460200058	Krytox GPL-205, oxygen compatible 57g (2oz)
331900268	Lubricant for high pressure cylinder valves
331900269	Silicone lubricant, for low pressure applications

Test equipment



Part No.	Description
336190128	Mini test

Transport boxes



Part No.	Description
30977-01	For Divator diving equipment with interior for one 323.4 / 2x3.5 L and one 326.7 / 2x 7.2 L and additional space for regulator, mask, BC etc.
30798-01	DP1 transport box for <70 meter DP1 hose, with interior and space for surface box or one cylinder pack.
30798-02	DP1 transport box for >70 meter DP1 hose, with interior but space for surface box.







A long history of innovation

Interspiro has left a considerable imprint on history within breathing protection and our technological milestones have frequently become industry standards. During the years we have received numerous distinctions for the quality of our equipment, but we are most proud of the fact that every day professional men and women all over the world trust us with their lives as they go, haste or swim to work.

